

Model	Max Fluid Flow 35 % Prop. Glycol (GPM)	External Available Pressure (ft)	Fluid Flow 35 % Prop. Glycol (GPM)	External Available Pressure (ft)	Min. Circuit Ampacity (MCA)			Max. Fuse (MOP)			Noise Level* @ 30 ft. (dBA)
					230 V	460 V	575 V	230 V	460 V	575 V	
NG-V-32	210	40	150	55	79.0	35.1	27.1	90	40	40	68 / 76



CAD FILE NG-V-32 CW Pump Kit rev00		
DATE	05/27/16	REV 0
DRAWN BY	Duc Tran	SHEET 1 OF 1

DESCRIPTION
NG-V VERTICAL AIR FLOW

48.0 US gal. internal fluid volume.

*First value with fan running at low speed, second value at high speed.
Values are for free field installation.
Noise levels may vary due to installation factor.

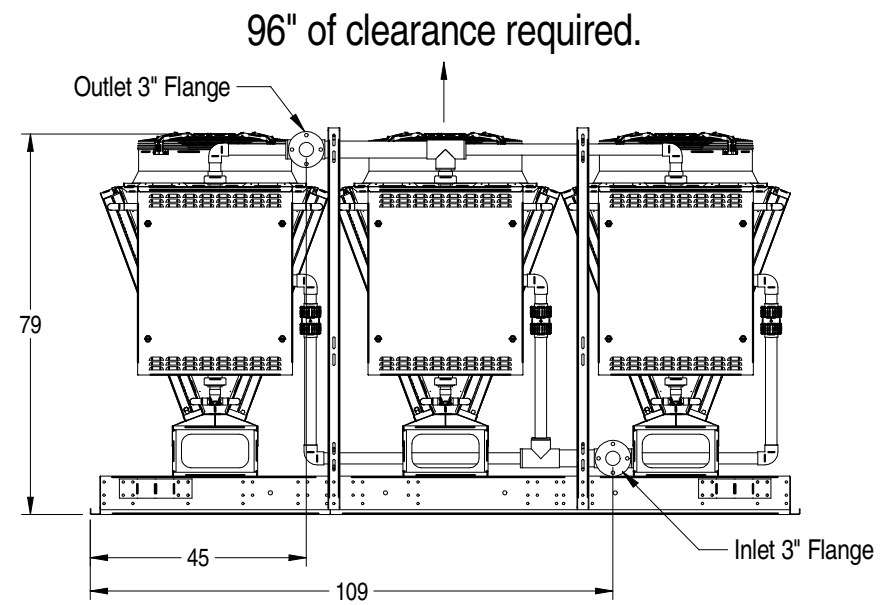
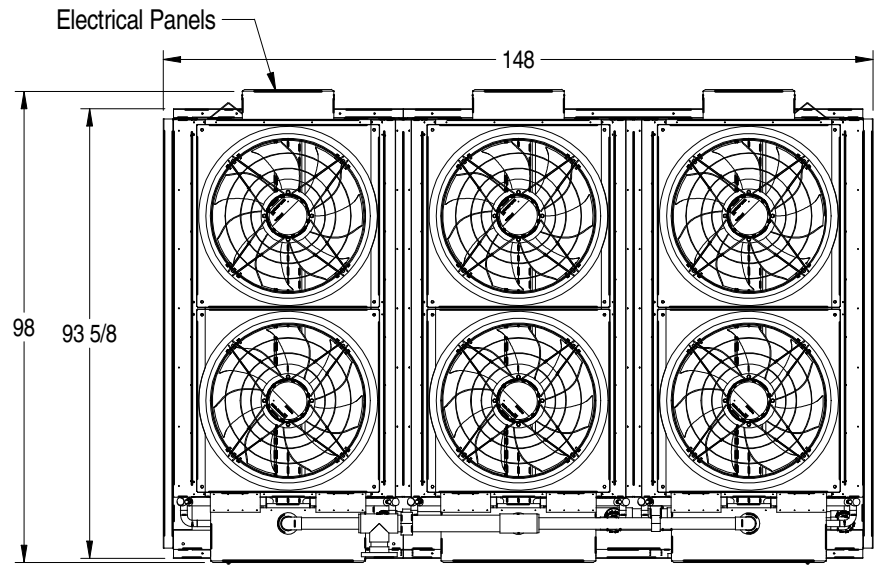
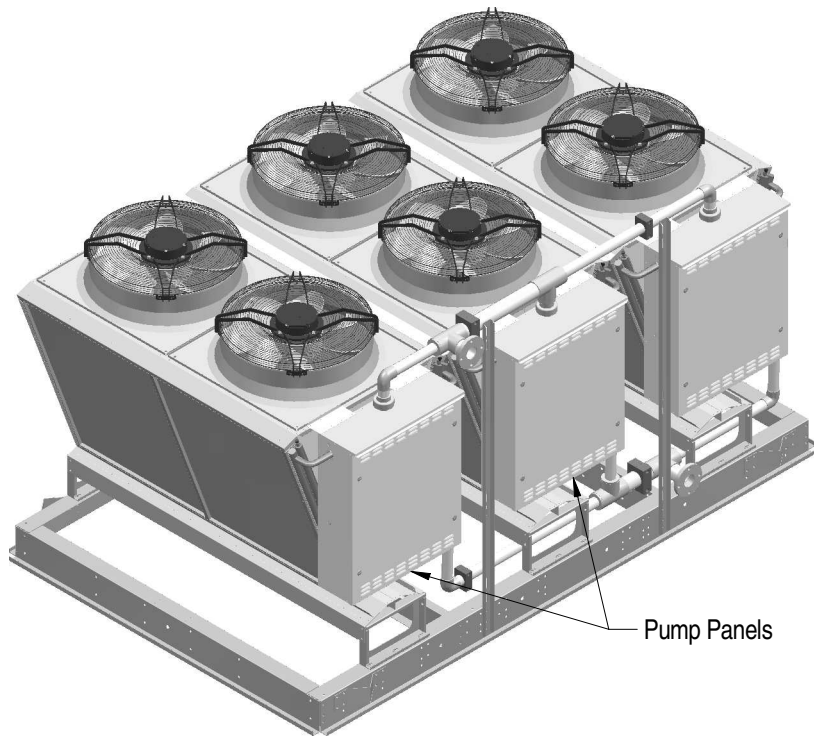

Important note:
Minimum 36" of clearance all the way around for proper air flow.

UNIT OPERATING WEIGHT: 3900 LBS